

| | Legenda: | Key: | Zeichenerklärung: | Légende: |
|--|--------------------------|--------------------------------|--------------------------|---------------------------------------|
| | Tappo di sfiato / carico | <i>Filling / breather plug</i> | Einfüll / Ablaßschraube | <i>Bouchon de event / remplissage</i> |
| | Tappo di livello | <i>Level plug</i> | Ölstandsschraube | <i>Bouchon de niveau</i> |
| | Tappo di scarico | <i>Drain plug</i> | Ölablaßschraube | <i>Bouchon de vidange</i> |
| | Tappo in vista | <i>Plug in sight</i> | Sichtbarer Deckel | <i>Bouchon visible</i> |
| | Tappo non in vista | <i>Plug not in sight</i> | Nicht sichtbarer Deckel | <i>Bouchon non visible</i> |

S_P

(B5)

_HS

_P (IEC)

_S

B3

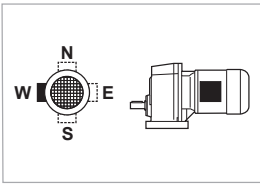
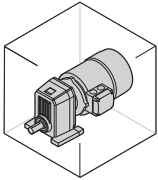

W = Default

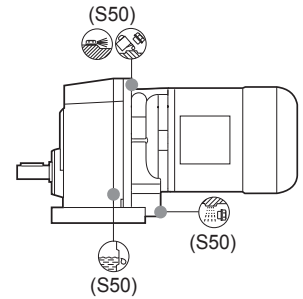
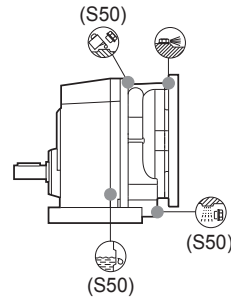
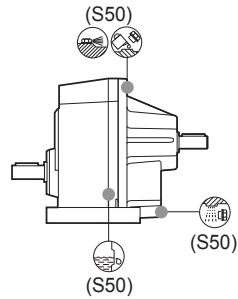

B6

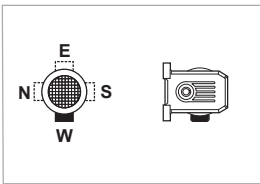
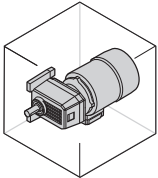

W = Default

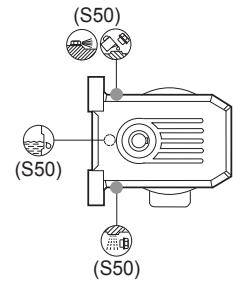
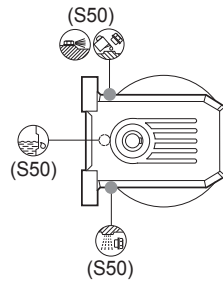
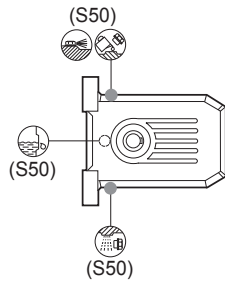

B7

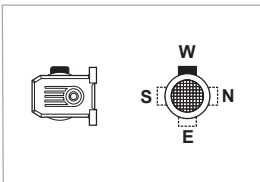
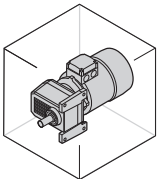

W = Default

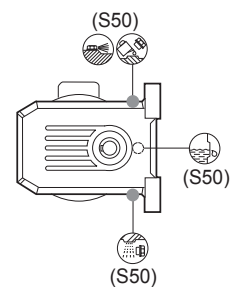
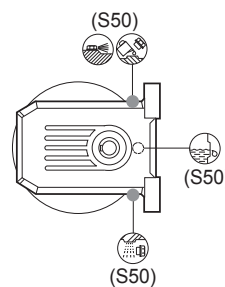
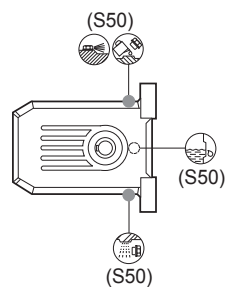

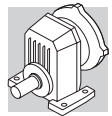

S_P

(B6)

_HS

_P (IEC)

_S

B8

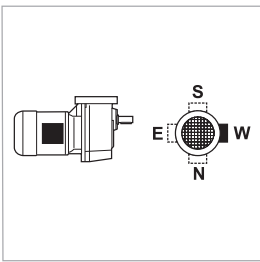
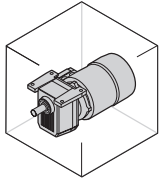

W = Default

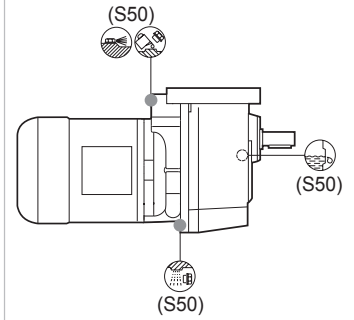
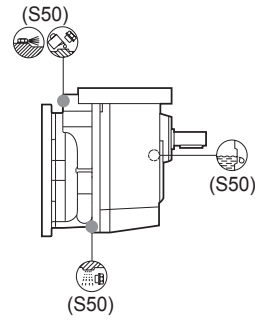
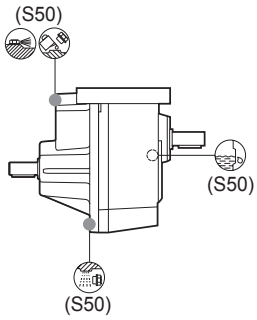

V5

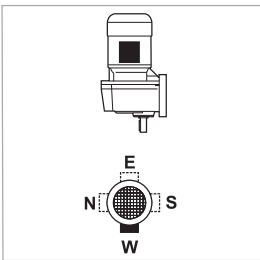
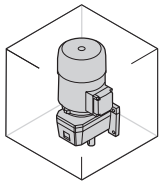

W = Default

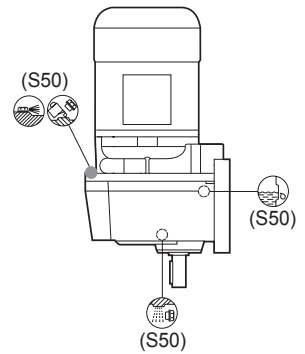
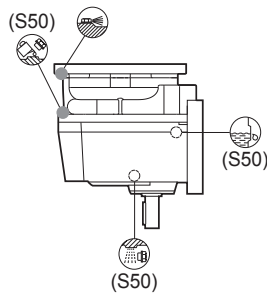
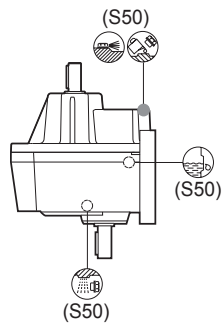

V6

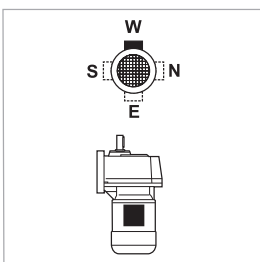
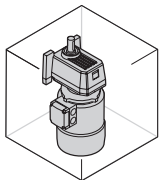

W = Default

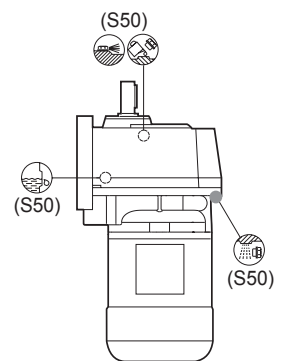
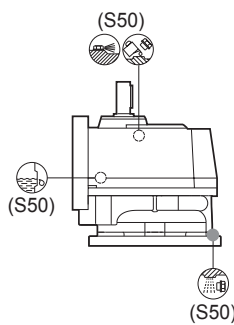
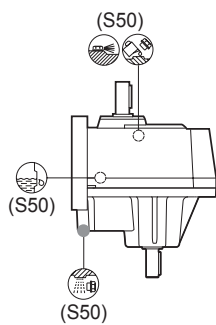

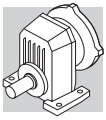

S_F

(B7)

_HS

_P (IEC)

_S

B5

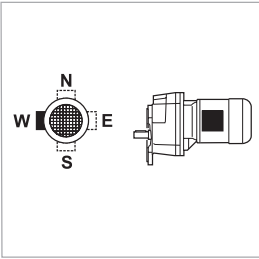
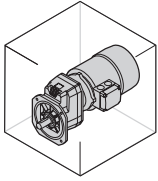

W = Default

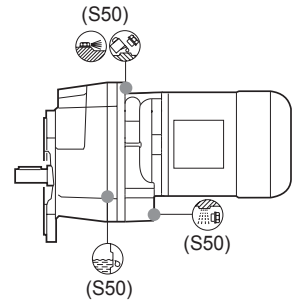
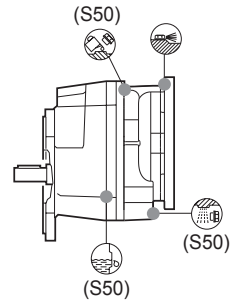
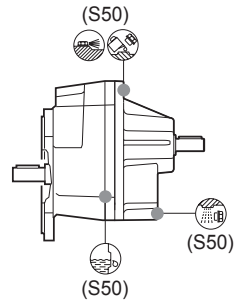

B51

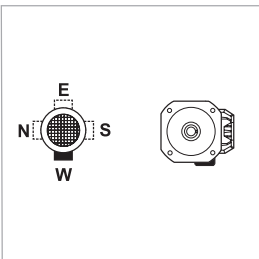
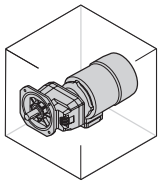

W = Default

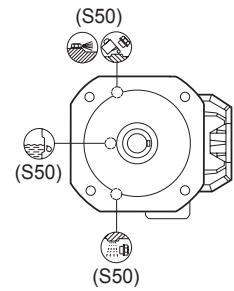
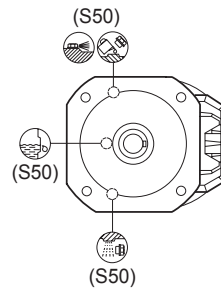
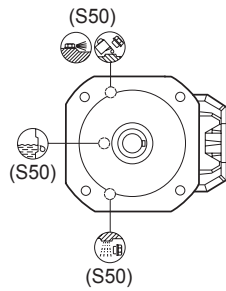

B53

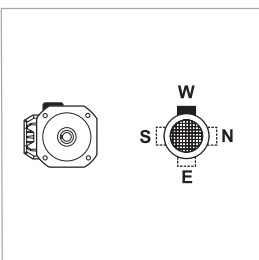
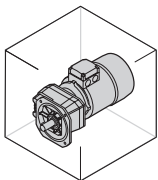

W = Default

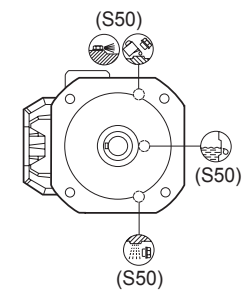
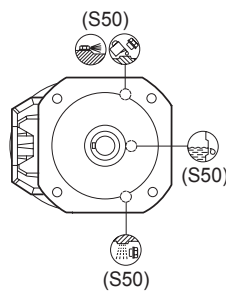
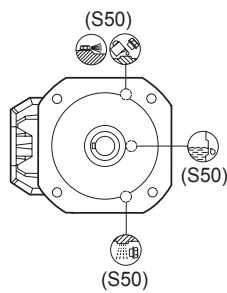

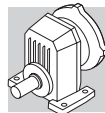

S_F

(B8)

_HS

_P (IEC)

_S

B52

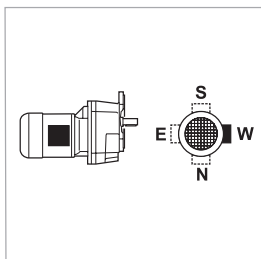
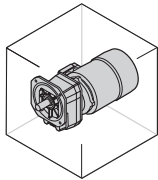

W = Default

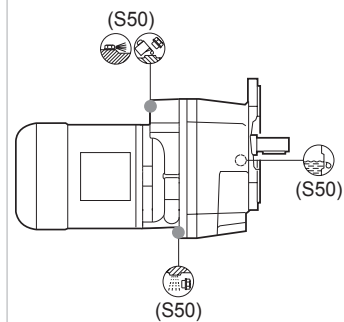
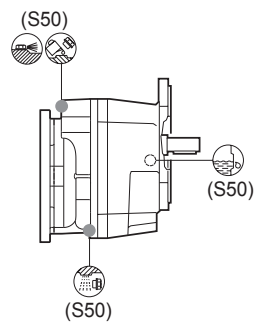
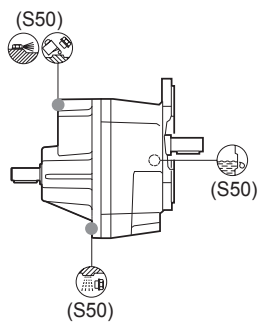

V1

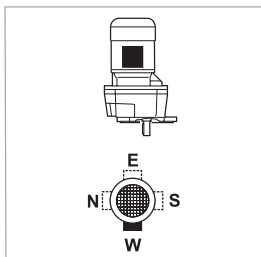
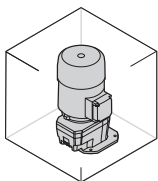

W = Default

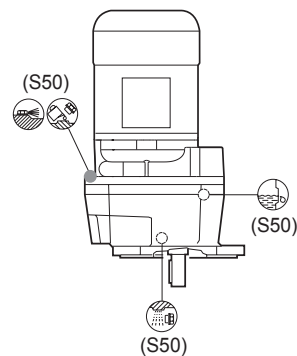
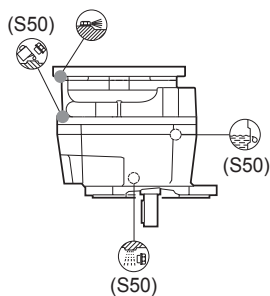
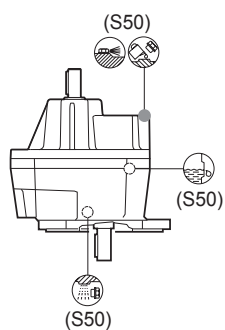

V3

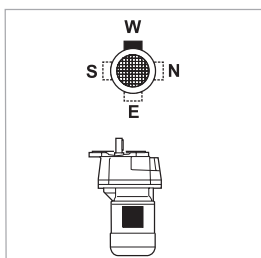
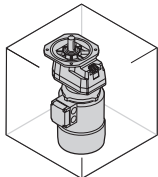

W = Default

